

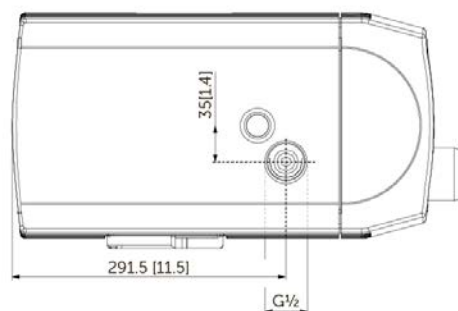

Model: **VT4.16**

SPECIFICATIONS

Volume flow 50 Hz	16 m ³ /h
Vacuum absolute 50 Hz	150 mbar
Power 50 Hz	0.55 kW
Noise Level 50 Hz	61.0 dB(A)
Volume flow 60 Hz	19 m ³ /h
Vacuum absolute 60 Hz	150 mbar
Power 60 Hz	0.70 kW
Noise Level 60 Hz	64.0 dB(A)
Weight	22.5 kg with motor

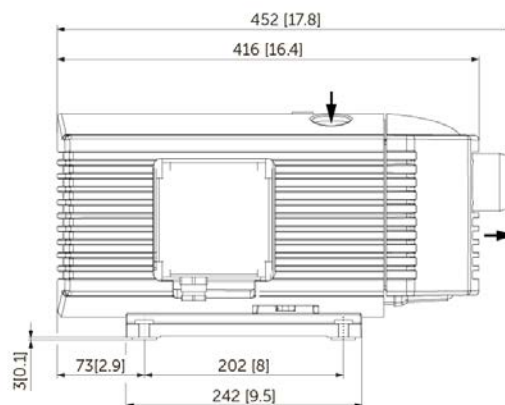
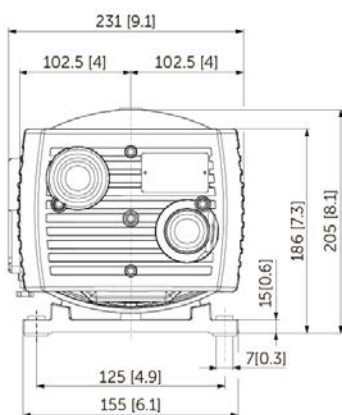

mm [inch]

BECKER VT 4.16